

**OUSILONG**<sup>®</sup>

Square  
Ceiling Series

013/

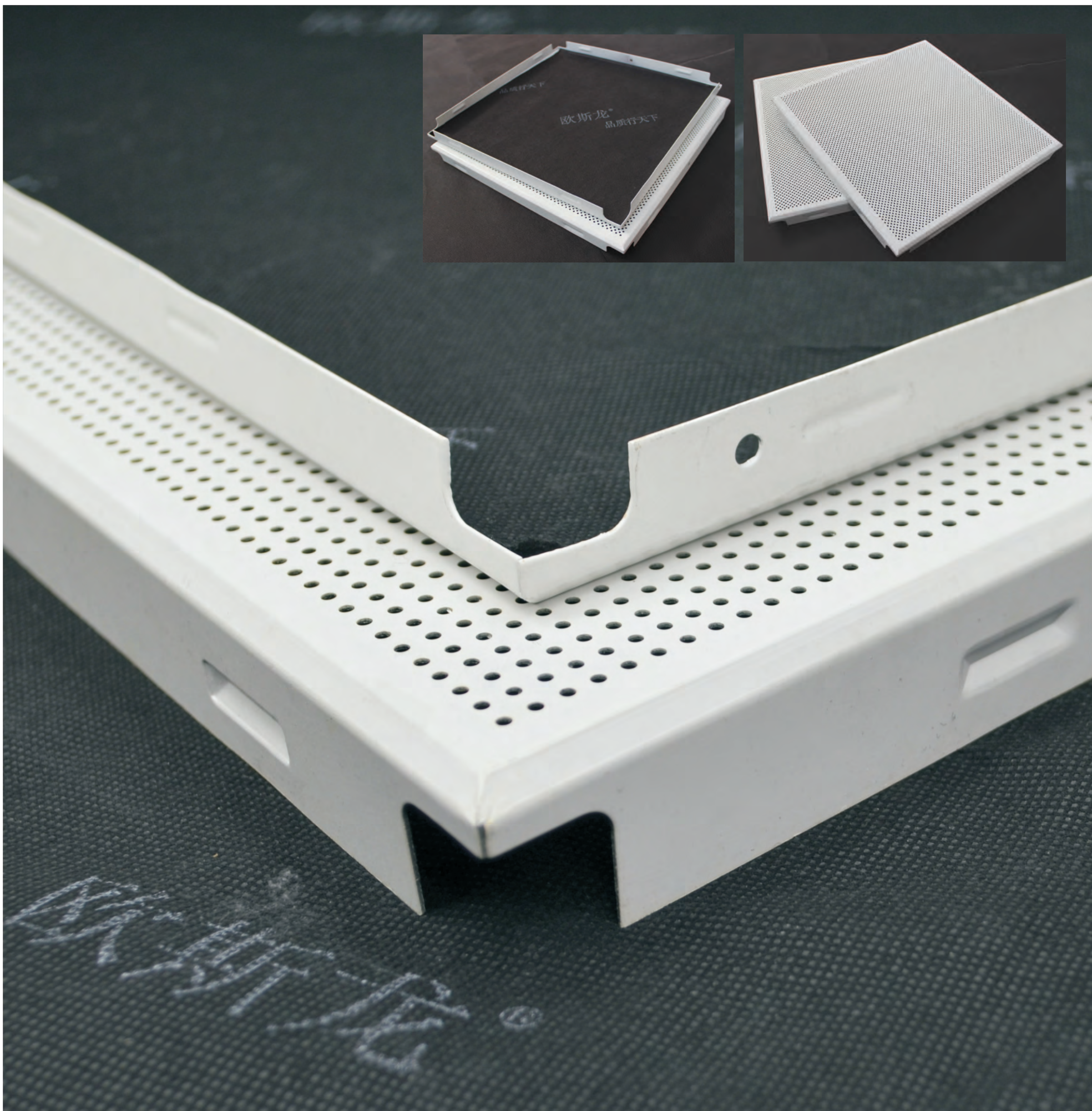

# Clip-in Ceiling

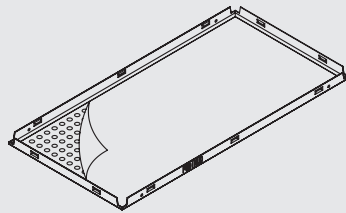

## Perforated panel

No.:PA6012T  
Materials:Grade AA aluminum alloy  
Surface finish:Akzo Nobel Powder coating  
Specifications:600mm × 1200mm  
Standard thickness:1.0mm

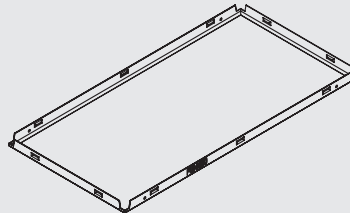

## Plain panel

No.:PA6012  
Materials:Grade AA aluminum alloy  
Surface finish:Akzo Nobel Powder coating  
Specifications:600mm × 1200mm  
Standard thickness:1.0mm

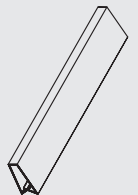

## A-shaped carrier

No.:PAL01  
Materials:Steel  
Surface finish:Galvanization  
Height :40mm  
Length:3000mm  
Standard thickness:0.5/0.6mm

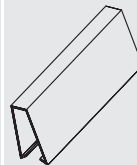

## A-shaped carrier connector

No.:PAL01L  
Materials:Steel  
Surface finish:Galvanization  
Height :35mm  
Length:100mm  
Standard thickness:0.35mm

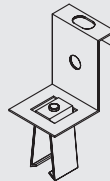

## A-shaped carrier hanger

No.:PAL0150J  
Materials:Steel  
Surface finish:Galvanization  
Height :78/103mm  
Standard thickness:1.0mm

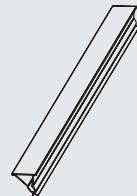

## Triangle carrier

No.:PBL01  
Materials:Steel  
Surface finish:Galvanization  
Height :24/28mm  
Length:3000mm  
Standard thickness:0.35/0.4mm

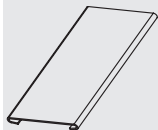

## Triangle carrier connector

No.:PBL01L  
Materials:Steel  
Surface finish:Galvanization  
Length:65mm  
Standard thickness:0.4mm



## Triangle carrier hanger

No.:PBL01J  
Materials:Steel  
Surface finish:Galvanization  
Height :90mm  
Standard thickness:0.6mm

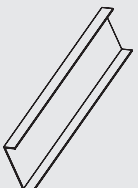

## Main runner

No.:PGG01  
Materials:Steel  
Surface finish:Galvanization  
Height :38/50mm  
Length:3000mm  
Standard thickness:0.6/0.8mm



## Main runner hanger

No.:PGG01J  
Materials:Steel  
Surface finish:Galvanization  
Height :85mm  
Standard thickness:1.0mm

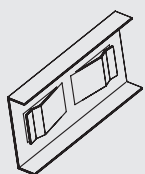

## Main runner connector

No.:PGG01L  
Materials:Steel  
Surface finish:Galvanization  
Height :35mm  
Standard thickness:0.7mm



## M8 bar

No.:PGG01D  
Materials:Steel  
Surface finish:Galvanization

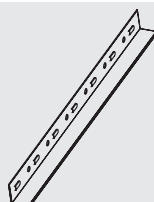

## L25 wall angle

No.:PXL02T  
Materials:Grade AA aluminum alloy  
Surface finish:Akzo Nobel powder coating  
Specifications:25mm × 25mm  
Length :3000mm  
Standard thickness:0.8mm

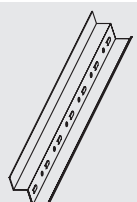

## W25 wall angle

No.:PXW02T  
Materials:Grade AA aluminum alloy  
Surface finish:Akzo Nobel powder coating  
Specifications:25mm × 25mm × 25mm  
Length :3000mm  
Standard thickness:0.8mm

## Installation Diagram

- ① M8 Bar
- ② Main Runner Hanger
- ③ Main Runner
- ④ Flat Ceiling
- ⑤ A-shaped Carrier Hanger
- ⑥ A-shaped Carrier

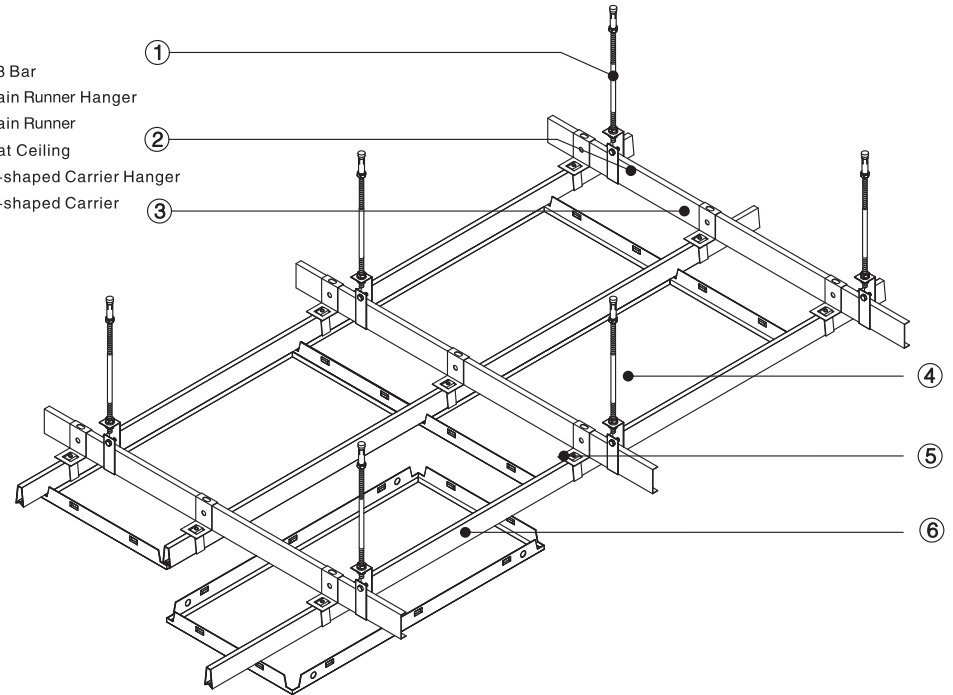

■ (Size): 300 × 300mm, 300x600mm, 300x1200mm, 300x1800mm, 400 × 400mm, 400x1800mm, 500x500mm, 600x600mm, 600x1200mm, 600x2400mm, 618x618mm, 800x800mm

Clip-in ceiling, also named open frame ceiling, was derived from Germany with advanced & unique production technology, which is the superior product of OUSILONG, with professional mold design, even panel surface, distinct edges & lines, and clear & concise. All of these create a pleasant visual space. OUSILONG ceilings feature at fireproof, anti-corrosion, thermo stability, and good weather resistance. The colors keep fresh for a long time. Many kinds of sizes are available. “#” -shaped roof beam, “#” -shaped partition, strip partition and other diving joint effect can be achieved. Matched with non-standard aluminum panel in installation, it will perform better. OUSILONG ceilings meet different design & requirements, widely used in all kinds of buildings. With reasonable prices, we can deliver goods in a week as fast as we can.

